

# MANUAL

## CONGRATULATIONS

on the purchase of your new CTEK charger providing professional battery care. This charger is included in a series of professional chargers from CTEK SWEDEN AB and represents the latest technology in battery charging. With the CTEK D250SA and SMARTPASS 120 you can be sure of getting maximum performance from your dual battery system.

## SAFETY

### CALIFORNIA PROPOSITION 65

**WARNING:** This product contains chemical known to the state of California to cause cancer or reproductive toxicity.

- The D250SA and SMARTPASS 120 have been developed for 12V lead-acid batteries. Do not use the unit for any other type of battery.
- Wear protective goggles when connecting and disconnecting batteries.
- Battery acid is corrosive. Rinse with plenty of water immediately if you get acid on your skin or in your eyes. Get medical assistance.
- Never use a charger with damaged electric cables. Check that the cables have not been damaged by hot surfaces, sharp edges or in any other way.
- Explosive gases are generated while lead-acid batteries are being charged. Avoid any sparking near the battery. Use in a well-ventilated location.
- Never place the charger above the battery, and avoid covering the charger during charging.
- Disconnect the battery terminal posts before installing.
- The D250SA and SMARTPASS 120 are not spark-free.
- The installation must include a fuse in accordance with the recommendations in the table "CABLE AND FUSE RECOMMENDATIONS".



### WARNING!

The D250SA and SMARTPASS 120 are not protected against reversed polarity.

**Remember that all installations in boats must comply with ISO 10133!**

1. The cabling from the batteries must have fuses near the batteries.
2. The batteries must be securely fastened in a ventilated space.
3. The cabling must be run through pipe ducting, separately from 230V/110V wiring (mains power), or secured by clips at every 30 cm/1 ft.
4. Cabling in the engine compartment must be temperature rated at 70°C/ 158°F.

## D250SA

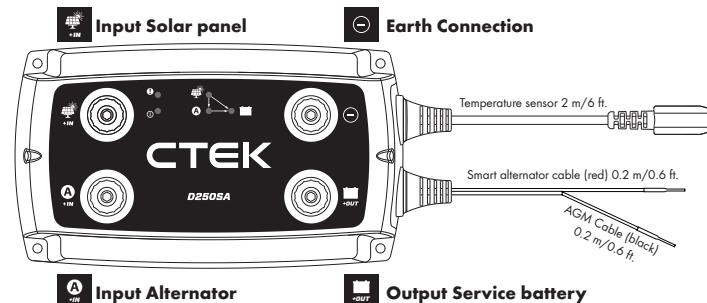

## SMARTPASS 120

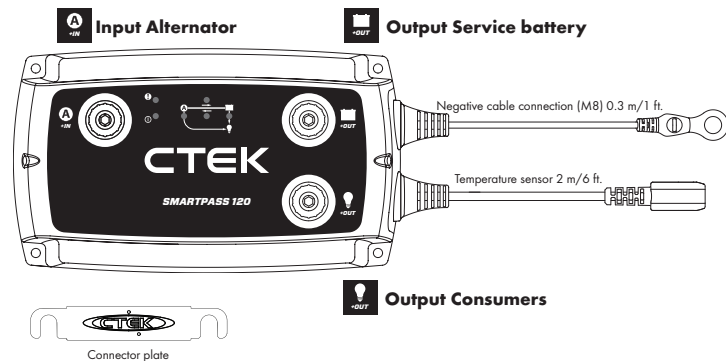

## D250SA

- The D250SA is a DC to DC battery charger for a dual battery system with a starter battery and a service battery.
- The D250SA charges the service battery either from an alternator or from a solar panel, or from a combination of both.
- The D250SA separates the batteries in a dual battery system and thereby replaces, for example, a separation relay, VSR (Voltage Sensitive Relay), diode isolator or a mechanical battery selector.
- The D250SA can be used on its own or in combination with SMARTPASS 120. In combination, the D250SA and SMARTPASS 120 can charge at up to 140A.

### FUNCTIONS:

- **Charging service battery from a conventional alternator (constant charging voltage)**  
The D250SA charges a service battery at up to 20A from the start battery when a conventional alternator is running. This function is switched off when the engine is not running to prevent discharge of the starter battery.
- **Charging of a service battery from a smart alternator (with variable charging voltage)**  
The D250SA can charge a service battery at up to 20A from the starter battery when a smart alternator is running. This function is switched off when the engine is not running, so as not to discharge the starter battery. The Installation section describes how the D250SA needs to be connected in order to activate the smart alternator functions.
- **Charging a service battery from a solar panel**  
The D250SA can charge and trickle charge a service battery from a solar panel at up to 20A. The D250SA uses MPPT (Maximum Power Point Tracker) to maximise the power from the solar panel.
- **Separation of the starter battery and the service battery**  
The D250SA separates the starter battery from the service battery when the engine is not running.
- **Temperature compensated charge voltage**  
The D250SA optimises the charge voltage by increasing the charge voltage at temperatures below 25°C/77°F and reducing it at temperatures higher than 25°C/77°F. The functions is always active.
- **Trickle charging of the starter battery from a solar panel**  
The D250SA trickle charges the starter battery from a solar panel at intervals of 3 seconds if the service battery is fully charged.
- **Optimised charging of AGM batteries**  
The D250SA can provide a suitable charging voltage for optimal charging of AGM (Absorbent Glass Mat) batteries, which require a higher charge voltage than other types of lead-acid battery. The installation section describes how the D250SA needs to be connected in order to activate the AGM battery function.

## SMARTPASS 120

- SMARTPASS 120 is a solution for supplying current to charge and manage consumers in a dual battery system consisting of a starter battery and a service battery.
- SMARTPASS 120 separates the batteries in a dual battery system and thereby replaces, for example, a separation relay, VSR (Voltage Sensitive Relay), diode isolator or a mechanical battery selector.
- SMARTPASS 120 connects the starter and service batteries together in order to charge them both from the alternator.
- SMARTPASS 120 protects the service battery from deep discharge which would damage the battery.
- SMARTPASS 120 supplies consumers from the alternator instead of from the service battery while the service battery is charging, which permits faster charging.
- SMARTPASS 120 can be used on its own or in combination with D250SA. In combination, the D250SA and SMARTPASS 120 can charge at up to 140A.

### FUNCTIONS:

- **Charging a service battery**  
SMARTPASS 120 charges the service battery from the starter battery or another current source that is connected when the alternator is running or when the starter battery voltage is high enough.
- **Battery guard**  
SMARTPASS 120 disconnects consumers when the service battery voltage is low in order to avoid deep discharge, which would damage the battery. The consumers are reconnected after the service battery voltage has increased. Connect critical consumers directly to the service battery so they will not be disconnected if the voltage falls to lower than 11.5V.
- **Start assistance**  
SMARTPASS 120 automatically connects the service battery to the starter battery for 10 sec to assist, if the starter battery on its own is unable to start the engine. After the start assistance function has been activated, SMARTPASS 120 will display a fault indication until starting has been achieved without using the start assistance function.
- **Separation of the starter battery and the service battery**  
SMARTPASS 120 separates the starter battery from the service battery when the engine is not running.
- **Assigning current source priority**  
SMARTPASS 120 can sense when the alternator is running and in that case supplies consumers with current from the starter battery to work with the D250SA and maximise charging efficiency. Otherwise the consumers are supplied with current from the service battery.
- **Dynamic overcurrent protection**  
SMARTPASS 120 has overcurrent protection to shield the product. Overcurrent protection permits maximum current to be sent from the alternator temporarily so that charging will be accelerated.
- **Battery temperature protection**  
SMARTPASS 120 protects the battery by switching off charging if the service battery temperature rises too high.
- **Starter battery trickle charging**  
The service battery trickle charges the starter battery without assistance from the solar panel or alternator to compensate for the self-discharge of the starter battery. The service battery charges in 3-second pulses when its voltage is higher than that of the starter battery and the voltage of the starter battery is low.

## FUNCTION INDICATIONS

D250SA		Explanation
1		The service battery is being charged by the alternator.
2		The service battery is being charged by the solar panel.
3		The service battery is being charged by both the alternator and solar panel.
4		The service battery is fully charged. The service battery is being trickle charged by the solar panel.
5		Current saving mode, no charging in progress.

SMARTPASS 120		Explanation
1		Current from alternator to service battery and consumers. Current from service battery to consumers.
2		Current from alternator to service battery and consumers.
3		Current from alternator to consumers. The service battery is charged by the D250SA.
4		Trickle charging of the starter battery from the service battery.

## CABLE AND FUSE RECOMMENDATIONS

		MIN. CABLE SIZE						FUSE
UNIT	CABLE	0.5 m 2 ft.	1 m 3 ft.	2 m 6 ft.	5 m 15 ft.	10 m 30 ft.		
D250SA		4 mm <sup>2</sup> / AWG12	4 mm <sup>2</sup> / AWG12	4 mm <sup>2</sup> / AWG12	6 mm <sup>2</sup> / AWG10	10 mm <sup>2</sup> / AWG8	30A	
		4 mm <sup>2</sup> / AWG12	6 mm <sup>2</sup> / AWG10	10 mm <sup>2</sup> / AWG8			30A	
SMARTPASS 120		4 mm <sup>2</sup> / AWG12	4 mm <sup>2</sup> / AWG12	4 mm <sup>2</sup> / AWG12	4 mm <sup>2</sup> / AWG12	4 mm <sup>2</sup> / AWG12		
	Connector plate*	4 mm <sup>2</sup> / AWG12	6 mm <sup>2</sup> / AWG10	10 mm <sup>2</sup> / AWG8	10 mm <sup>2</sup> / AWG8	10 mm <sup>2</sup> / AWG8		
SMARTPASS 120		35 mm <sup>2</sup> / AWG2	35 mm <sup>2</sup> / AWG2	35 mm <sup>2</sup> / AWG2	50 mm <sup>2</sup> / AWG1	50 mm <sup>2</sup> / AWG1	300A	
		35 mm <sup>2</sup> / AWG2	35 mm <sup>2</sup> / AWG2	35 mm <sup>2</sup> / AWG2			300A	

\* If the D250SA and SMARTPASS 120 are installed in different locations and the accompanying connector plate is not used, please follow the recommendations in the table.

## INSTALLATION

1. Install the apparatus on a smooth surface where it can be firmly secured and where it is not exposed to fuel, oil or dirt. To obtain the correct distance, start by fitting the two units together with the accompanying connector plate (see Figure 3) before they are finally fastened to the smooth surface.
2. Secure the apparatus with, for example, M4 or ST4.2 screws at each corner (see Figure 1).
3. Before connecting the cables, ensure that the negative terminal post on the battery is not connected.
4. Connect the cables to the apparatus connections by securing screws (M8) (see Figure 2). Use an Allen key - tightening by hand without a tool is not enough.
5. Use tape (see Figure 4) to secure the temperature sensor to a clean flat surface above the service battery. Position the sensor as close to the positive terminal post as possible.
6. Connect the battery negative terminal post.

Figure 4

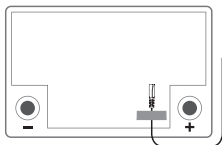

### WARNING!

The D250SA and SMARTPASS 120 are not protected against reversed polarity. Disconnect the battery terminal posts before installation.



### WARNING!

The D250SA and SMARTPASS 120 are not spark-free. Ensure good ventilation.

## RECOMMENDED TIGHTENING TORQUES

Figure 1

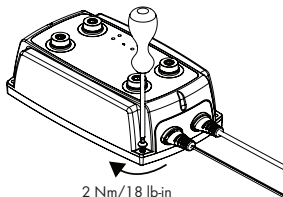
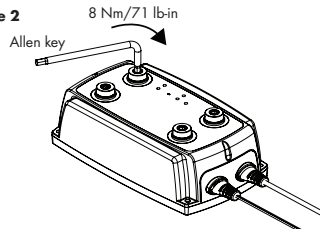
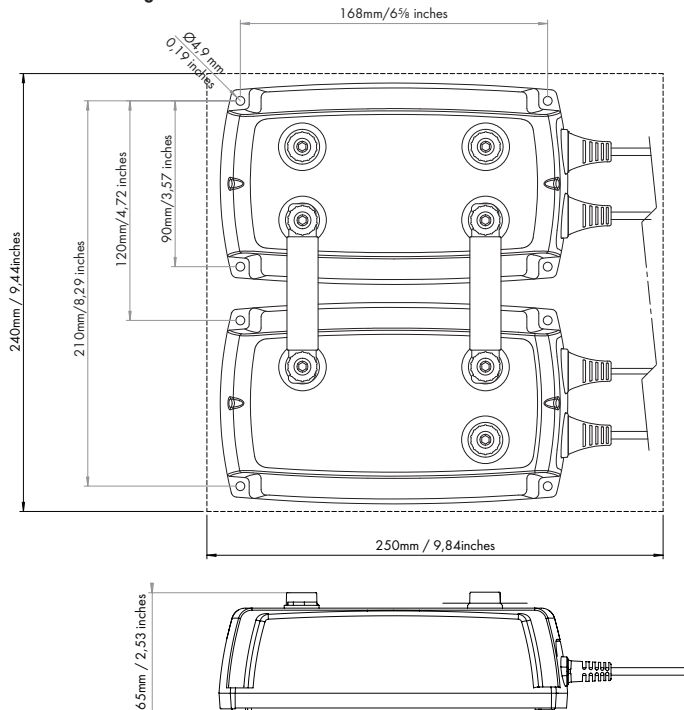

Figure 2



## DIMENSIONS

Figure 3



## SETTINGS D250SA

Smart alternator cable (red)	Type of alternator	AGM cable (black)	Charging voltage
Not connected	Conventional alternator	Not connected	14.4V
Connected	Smart alternator	Earth	14.7V

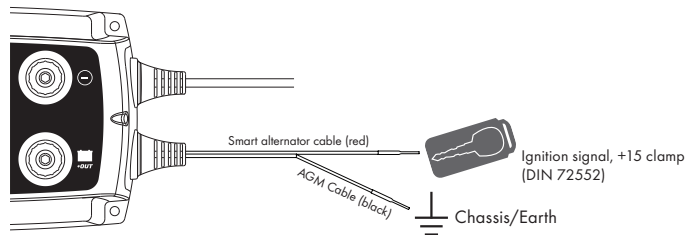

## SYMBOLS

Fuse		See "CABLE AND FUSE RECOMMENDATIONS"	
Flashing lamp		Continuously lit lamp	
Solar panel		Non critical consumer	
Alternator		Critical consumer	

## Connection

## Connected to

D250SA		
Input Solar panel		<ul style="list-style-type: none"> <li>Solar panel (* see technical specification)</li> <li>Wind generator *</li> <li>Other DC source *</li> </ul>
Input Alternator		<ul style="list-style-type: none"> <li>Starter battery</li> <li>Input Alternator SMARTPASS 120 via connector plate or cable</li> </ul>
Output Service battery		<ul style="list-style-type: none"> <li>Service battery</li> <li>Output Service battery SMARTPASS 120</li> </ul>
Earth Connection		<ul style="list-style-type: none"> <li>Chassis/Earth</li> <li>Solar panel (-)</li> <li>SMARTPASS 120 (-)</li> </ul>
Smart alternator cable (red)		Ignition signal, +15 clamp (DIN 72552)
AGM Cable (black)		Chassis/Earth
SMARTPASS 120		
Input Alternator		<ul style="list-style-type: none"> <li>Starter battery</li> <li>Input Alternator D250SA via connector plate or cable</li> </ul>
Output Service battery		Output Service battery D250SA
Output Consumers		Non-critical consumers

## INSTALLATION EXAMPLES

### 1. Solar panel

#### PREREQUISITES

Solar panel capable of charging a 40–300Ah service battery. The D250SA uses MPPT (Maximum Power Point Tracker) to maximise the power from a solar panel.

#### TIP 1

Do not connect two solar panels in series. Max. input voltage 23V.

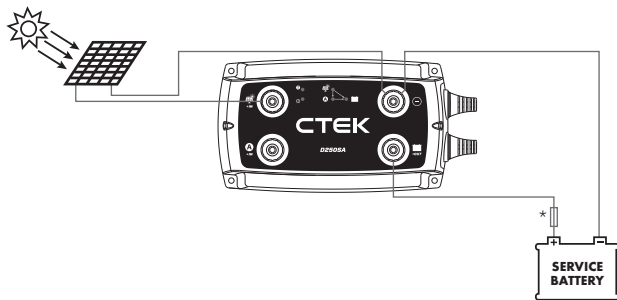

\*See "CABLE AND FUSE RECOMMENDATIONS"

### 2. Small service battery

#### PREREQUISITES

A dual battery system where the D250SA charges a 40–300Ah service battery from a generator which also charges a starter battery.

It is advantageous to use this installation when:

- The alternator is unable to deliver the desired charging voltage.

#### TIP 2

If the alternator has external voltage detection for the service battery, the voltage detection wiring must be connected to the starter battery.

#### TIP 3

Complement the D250SA with a SMARTPASS 120 if the service battery capacity is greater than 100Ah or has parallel consumption while charging is in progress. This reduces the charging time.

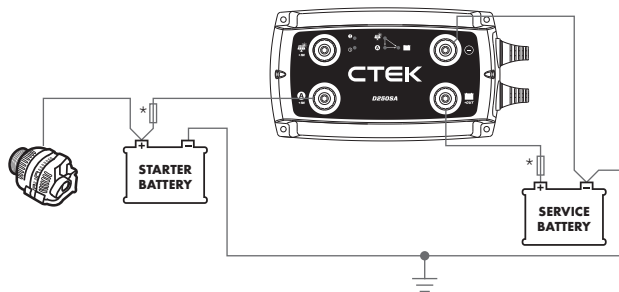

\*See "CABLE AND FUSE RECOMMENDATIONS"

### 3. Small service battery and solar panel

#### PREREQUISITES

A dual battery system where the D250SA charges a 40-300Ah service battery from a solar panel, an alternator, or both which also charge a starter battery.

It is advantageous to use this installation when:

- The alternator is not able to deliver the desired charge voltage.
- Charging from a solar panel.

See also tips 1, 2 and 3.

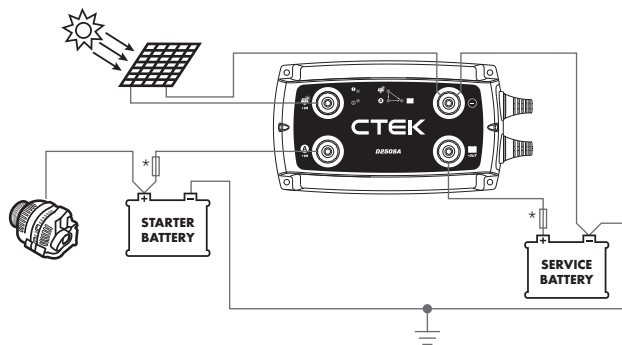

\*See "CABLE AND FUSE RECOMMENDATIONS"

### 4. Service battery with parallel consumers

#### PREREQUISITES

A dual battery system where the SMARTPASS 120 charges a 28-800Ah service battery from an alternator which also charges a starter battery.

It is advantageous to use this installation when:

- The alternator is able to deliver the desired charging voltage.
- The service battery capacity is greater than 100 Ah.

- The consumers are supplied directly from the alternator at the same time as the service battery is being charged.

See also tips 2 and 3.

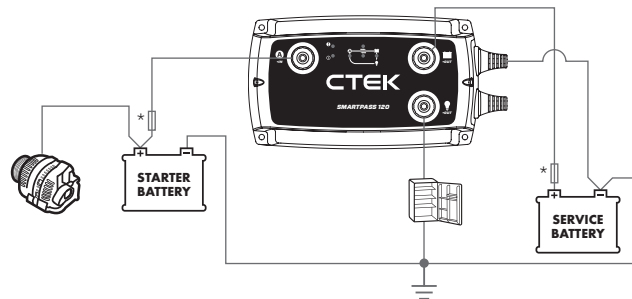

\*See "CABLE AND FUSE RECOMMENDATIONS"

## 5. Large service battery with parallel consumers

### PREREQUISITES

A dual battery system where a D250SA together with a SMARTPASS 120 charges a 100–800Ah service battery. Current is supplied from a solar panel and/or an alternator. The starter battery is charged from an alternator.

It is advantageous to use this installation when:

- The alternator is not able to deliver the desired charging voltage.
- The service battery capacity is greater than 100Ah.
- Parallel consumption takes place during charging. By connecting the consumers to the Output Consumers on the SMARTPASS 120, the service battery will be able to charge without parallel consumption and the consumers

will instead be supplied with current from the alternator.

- The service battery shall be protected against deep discharge. Connect non-critical consumers to the Output Consumers on the SMARTPASS 120. Connect critical consumers directly to the service battery. SMARTPASS 120 does not in that case switch off the critical consumers when the service battery is completely discharged.

### TIP 4

Connect the cabling from the starter and service batteries respectively to the SMARTPASS 120 and not to the D250SA.

See also tips 1, 2 and 3.

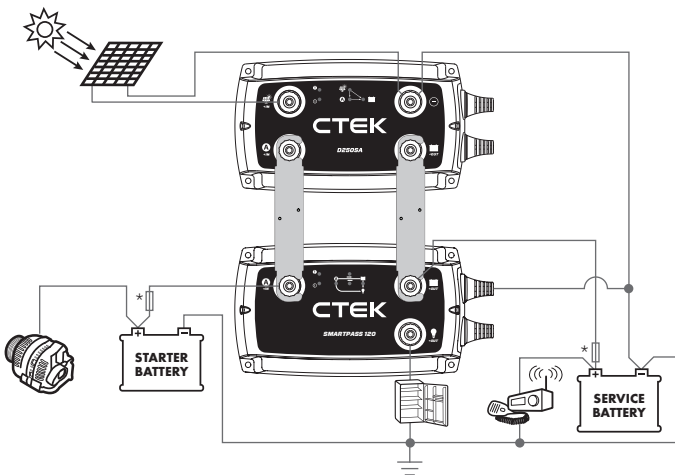

\*See "CABLE AND FUSE RECOMMENDATIONS"

## 6. Connect an AC/DC charger

### PREREQUISITES

A dual battery system where there is a 230/110V charger and a D250SA that, together with a SMARTPASS 120, charge a service battery with a capacity of 150–800Ah. Current is supplied from a solar panel and/or an alternator to the service battery. The starter battery is charged from an alternator.

It is advantageous to use this installation when:

- The charge from the alternator while it is charging (engine running) is not enough, so it has to be supplemented by a 230/110V charger.
- The alternator is not able to deliver the desired charge voltage.
- The service battery capacity is greater than 150Ah.

- Parallel consumption while charging is taking place. By connecting the consumers to the Output Consumers on the SMARTPASS 120, the service battery will be able to charge without parallel consumption and the consumers will instead be supplied with current from the alternator.

### TIP 5

Connect a 230/110V charger to the starter battery if it needs charging. In that case both the starter and service batteries will be optimally charged from the 230/110V charger.

### TIP 6

Heavy current consumers (more than 80A) must be connected directly to the service or starter battery.

See also tips 1, 2, 3 and 4.

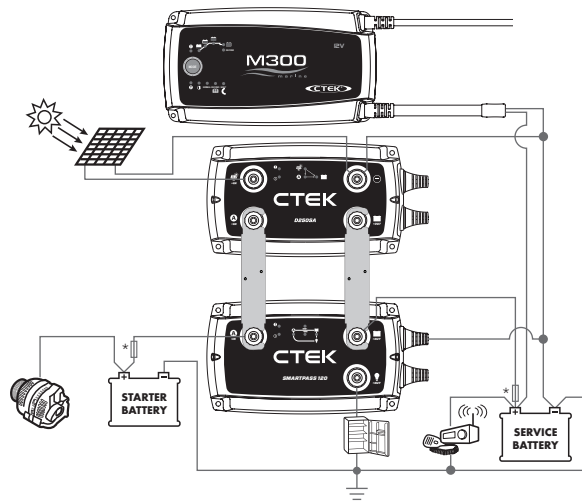

\*See "CABLE AND FUSE RECOMMENDATIONS"



## D250SA CHARGING PROGRAM

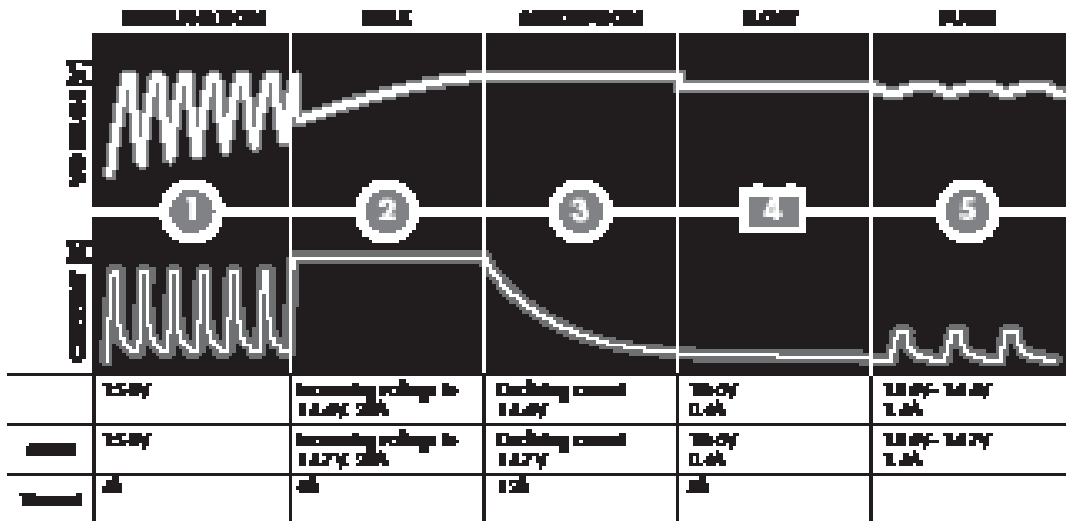

### STEP 1 DESULPHATION

Detects sulphated batteries. Pulsing current and voltage, removes sulphate from the lead plates of the battery restoring the battery capacity.

### STEP 2 BULK

Charging with maximum current until approximately 80% battery capacity.

### STEP 3 ABSORPTION

Charging with declining current to maximize up to 100% battery capacity.





### STEP 4 FLOAT

Maintaining the battery voltage at maximum level by providing a constant voltage charge.







### STEP 5 PULSE

Maintaining the battery at 95-100% capacity. The charger monitors the battery voltage and gives a pulse when necessary to keep the battery fully charged.

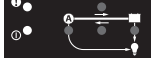
## D250SA FAULT INDICATIONS

	<p><b>Reason:</b> The apparatus and/or the service battery has a temperature that is too high.  <b>Recommendation:</b> Consider moving the apparatus and/or the service battery to a cooler location.</p>
	<p><b>Reason:</b> The service battery has a connection problem.  <b>Recommendation:</b> Check the connections of the service battery and its fuse.</p>
	<p><b>Reason:</b> The service battery has a connection problem.  <b>Recommendation:</b> Check the connections of the service battery and its fuse.</p>
	<p><b>Reason:</b> The service battery has a connection problem.  <b>Recommendation:</b> Check the connections of the service battery and its fuse.</p>

## SMARTPASS 120 FAULT INDICATIONS

	<p><b>Reason:</b> Service battery is overheating.  <b>Recommendation:</b> Check the service battery with a battery tester and/or check the installation.</p>
	<p><b>Reason:</b> Excessive current or internal temperature too high. Charging current too high to the service battery.  <b>Recommendation:</b> Check the service battery with a battery tester. Reduce the alternator size or connect another D250SA in parallel. The service battery is too deeply discharged.</p>
	<p><b>Reason:</b> Excessive current or internal temperature too high. Too many consumers connected simultaneously.  <b>Recommendation:</b> Consider moving the apparatus to a cooler location or reduce the use of consumers.</p>
	<p><b>Reason:</b> Excessive current or internal temperature too high. Current to the starter battery too high.  <b>Recommendation:</b> Check the starter battery with a battery tester. Replace the starter battery if the warning repeats.</p>
	<p><b>Reason:</b> Excessive current or internal temperature too high. Too many consumers connected.  <b>Recommendation:</b> Consider moving the apparatus to a cooler location or reduce the use of consumers.</p>
	<p><b>Reason:</b> Battery guard activated. Service battery not charged enough.  <b>Recommendation:</b> Charge the service battery.</p>
	<p><b>Reason:</b> Start assistance activated.  <b>Recommendation:</b> Charge the starter battery. Replace the starter battery if the warning repeats.</p>

## TECHNICAL SPECIFICATION

PRODUCT	D2505A	SMARTPASS 120
<b>Model number</b>	1044	1058
<b>Input</b>	11.5–23V, 25A	11.5–23V, Max 120A (350A temporarily for 10 seconds.)
<b>Output</b>	Max 14.4V (14.7V in AGM), 20A	Max. 23V, 120A
<b>Back current drain</b>	Less than 1Ah/month	Less than 7Ah/month
<b>Ripple*</b>	Less than 4%	Not applicable
<b>Ambient temperature</b>	-20°C to +50°C (-4°F to +122°F)	
<b>Power reduction</b>	30°C 16A, 50°C 13A	
<b>Temperature-compensated charging voltage</b>	23 mV/°C from 25°C/77°F	
<b>Battery types</b>	All types of 12V lead-acid batteries (WET, EFB, Ca/Ca, MF, AGM and GEL)	
<b>Battery capacity</b>	40–300Ah	28–800Ah
<b>Dimensions</b>	192 x 110 x 65mm (L x W x H)	
<b>Enclosure class</b>	IP65 (splash and dust proof)	
<b>Weight</b>	0.7 kg (1.5 lbs)	
<b>Recommended solar panel size</b>	50–300 W	
<b>MPPT**</b>	Yes	No
<b>Conventional alternator cut-in</b>	>13.1V, for 5 sec. (engine running, alternator charging)	
<b>Conventional alternator cut-out</b>	<12.8V, for 10 sec. (engine running, alternator not charging) or service battery voltage > starter battery voltage	
<b>Smart alternator cut-in</b>	>11.8V, for 5 sec. (engine running, alternator charging)	
<b>Smart alternator cut-out</b>	<11.4V, for 10 sec. (engine running, alternator not charging) or service battery voltage > starter battery voltage	
<b>Battery guard cut-in</b>	<11.5V	
<b>Battery guard cut-out</b>	>12.0V	
<b>Temperature protection cut-in</b>	>60°C (140°F)	
<b>Start assistance activation</b>	Starter battery <6V	
<b>Trickle charge starter battery</b>	Starter battery 11.5V–12.6V.	

\*) The quality of the charge voltage and charge current is very important. A high current ripple heats up the battery which has an aging effect on the positive electrode. High voltage ripple could harm other equipment that is connected to the battery. CTEK battery chargers produce very clean voltage and current with low ripple.

\*\*\*) MPPT (Maximum Power Point Tracker) finds the best combination of current and voltage so that the output power is maximised.

## LIMITED WARRANTY

CTEK issues this limited warranty to the original purchaser of this product. This limited warranty is not transferable. The warranty applies to manufacturing faults and material defects. The customer must return the product together with the receipt of purchase to the point of purchase. This warranty is void if the product has been opened, handled carelessly or repaired by anyone other than CTEK or its authorised representatives. One of the screw holes in the bottom of the product may be sealed. Removing or damaging the seal will void the warranty. CTEK makes no warranty other than this limited warranty and is not liable for any other costs other than those mentioned above, i.e. no consequential damages. Moreover, CTEK is not obligated to any warranty other than this warranty.

## SUPPORT

Visit: [www.ctek.com](http://www.ctek.com) for support, FAQ, the most recent version of the user instructions and further information concerning CTEK products.